

PUBLIC ADDRESS / SPEAKERS / CEILING

SKY-6

LOW IMPEDANCE CEILING SPEAKER



IP44



SALT MIST RESISTANCE



3-POINT ANCHORAGE



ANTI-DROP SYSTEM



TAP-LOCK TERMINALS



TURN-LOCKABLE GRILLE

- ✓ Low profile aluminium grille
- ✓ Highly conductive quick-connect terminals
- ✓ Anti-fall system for installation assistance
- ✓ Stable ceiling mounting brackets



+ Info:
<https://fonestar.com/SKY-6>

ESPECIALLY RECOMMENDED IN:



Hospitality



Retail



Hotels



All sectors

DESCRIPTION

Low impedance ceiling loudspeaker 700;">

TECHNICAL CHARACTERISTICS

FEATURES	<p>Low impedance ceiling loudspeaker.</p> <p>Low profile frameless grille, constructed from rust resistant aluminium. Detachable, turn-lockable. The logo can be removed and the speaker can be painted.</p> <p>Fast connection terminals and high conductivity.</p> <p>Anti-fall system for installation assistance.</p> <p>Hook for safety cable.</p> <p>Stable, worm-gear ceiling brackets.</p> <p>Protection against dust and water.</p>
POWER	<p>15 W RMS</p> <p>20 W MAX.</p>
SPEAKER	6" polypropylene double cone diaphragm
RESPONSE	<p>55-18,000 Hz @ -10 dB</p> <p>85-7,500 Hz @ -3 dB</p>
IMPEDANCE	8 Ohm
SENSITIVITY	88 dB @ 1 W/1 m
SOUND PRESSURE	<p>97 dB @ max. W/1m Continuous</p> <p>100 dB @ max. W/1m Peak</p>
COVERAGE ANGLE	H/V (-6 dB): 150°@500Hz, 150°@1kHz, 90°@2kHz, 60°@4kHz
PROTECTIONS	<p>IP-44 in compliance with EN 60529</p> <p>EN ISO 9227:2006 Neutral Salt Spray Test</p>
MATERIAL	<p>ABS (UV resistant)</p> <p>Liquid paint aluminium grille</p>
CONNECTORS	<p>Highly conductive quick-connect terminals</p> <p>For 0.4 ~ 4 mm² cross section cable</p>
OPERATION TEMPERATURE	5°C ~ 40°C
STORAGE TEMPERATURE	2°C ~ 50°C
MAXIMUM HUMIDITY	0.9



+ Info:
<https://fonestar.com/SKY-6>

COLOUR	White (RAL 9003)
DIMENSIONS	Total loudspeaker: 249 mm Ø x 85 mm height Grille section: 5 mm Recessed height: 80 mm Installation hole: 219 mm Ø Maximum ceiling thickness: 30 mm
WEIGHT	0.7 kg
ACCESSORIES	Installation template



+ Info:
<https://fonestar.com/SKY-6>

SPL vs Frequency

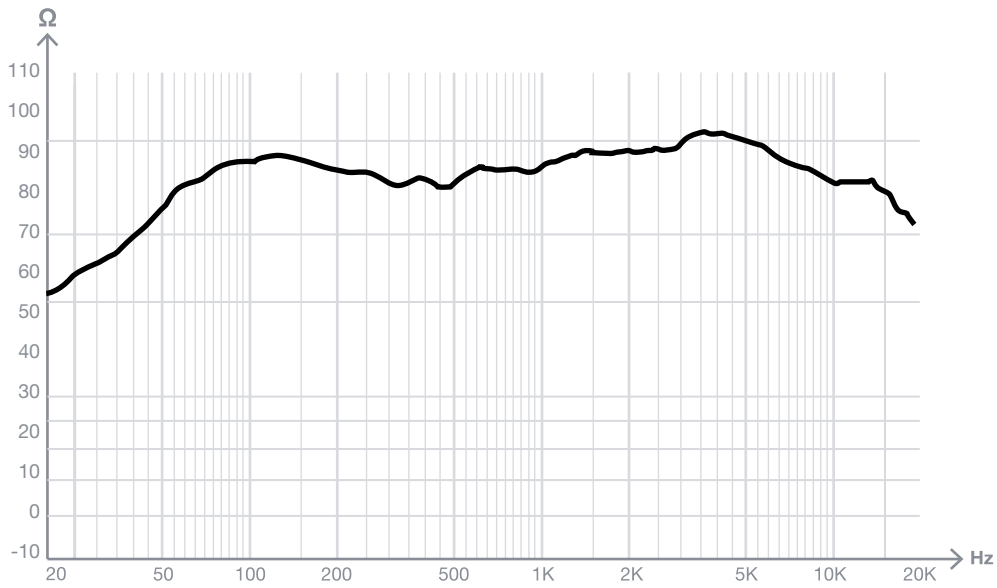

SPL vs Angle

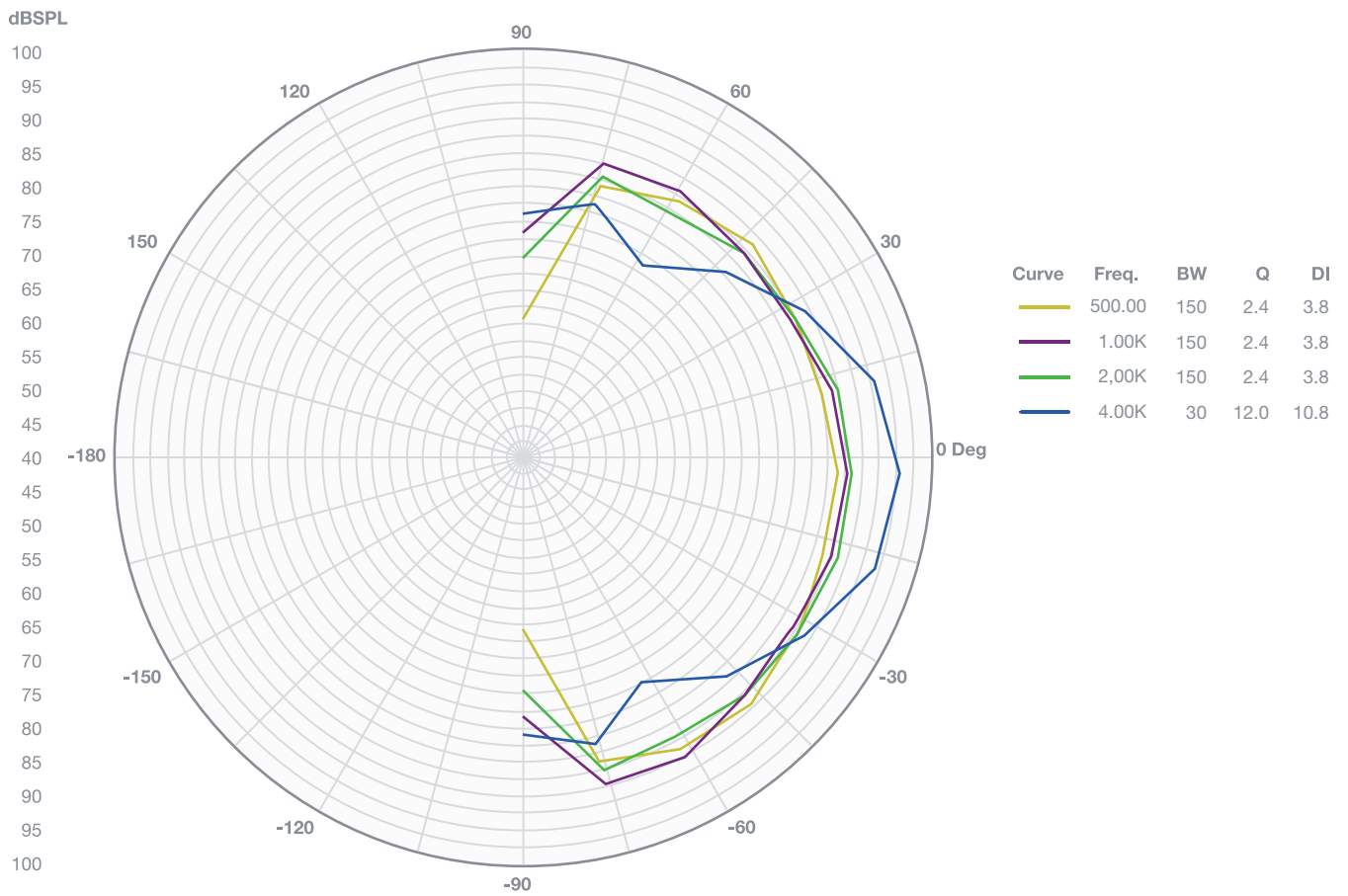

+ Info
<https://fonestar.com/SKY-6>

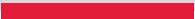

● ↕ → Impedance vs Frequency

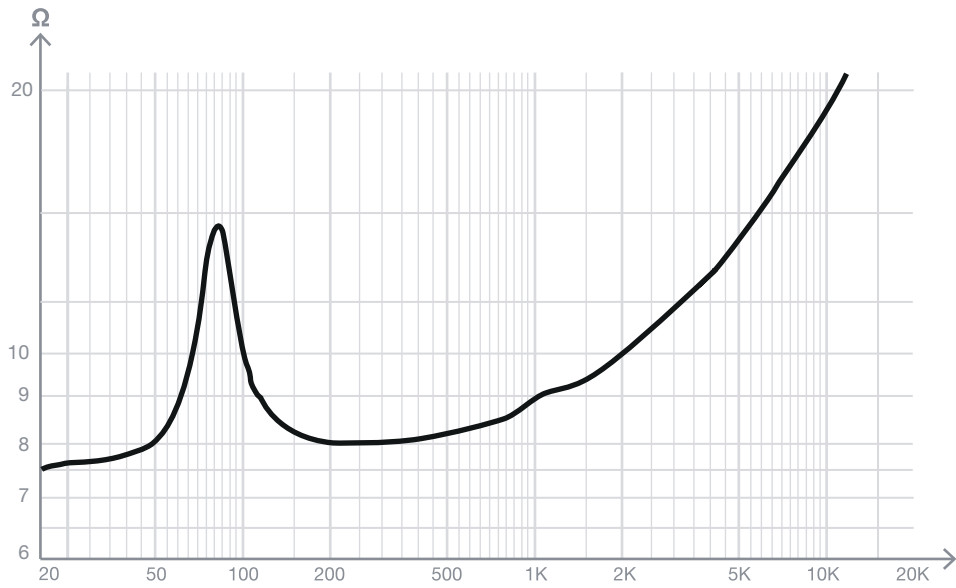

+ Info
<https://fonestar.com/SKY-6>

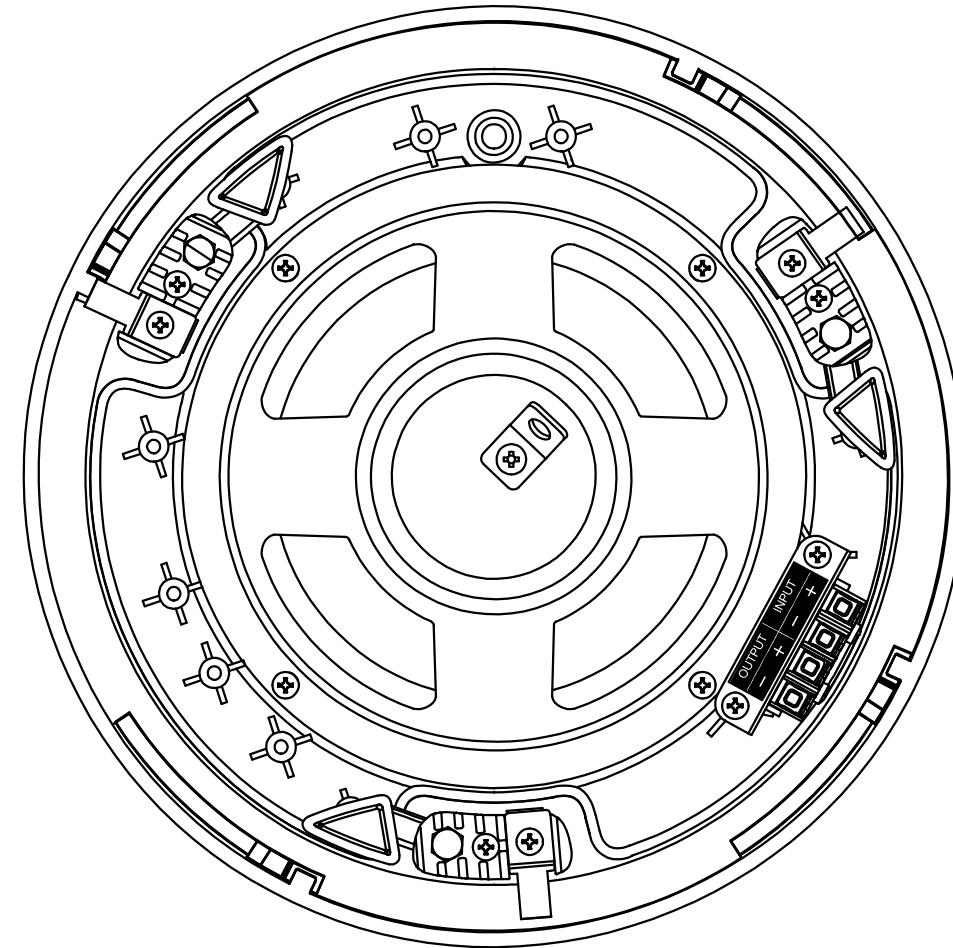
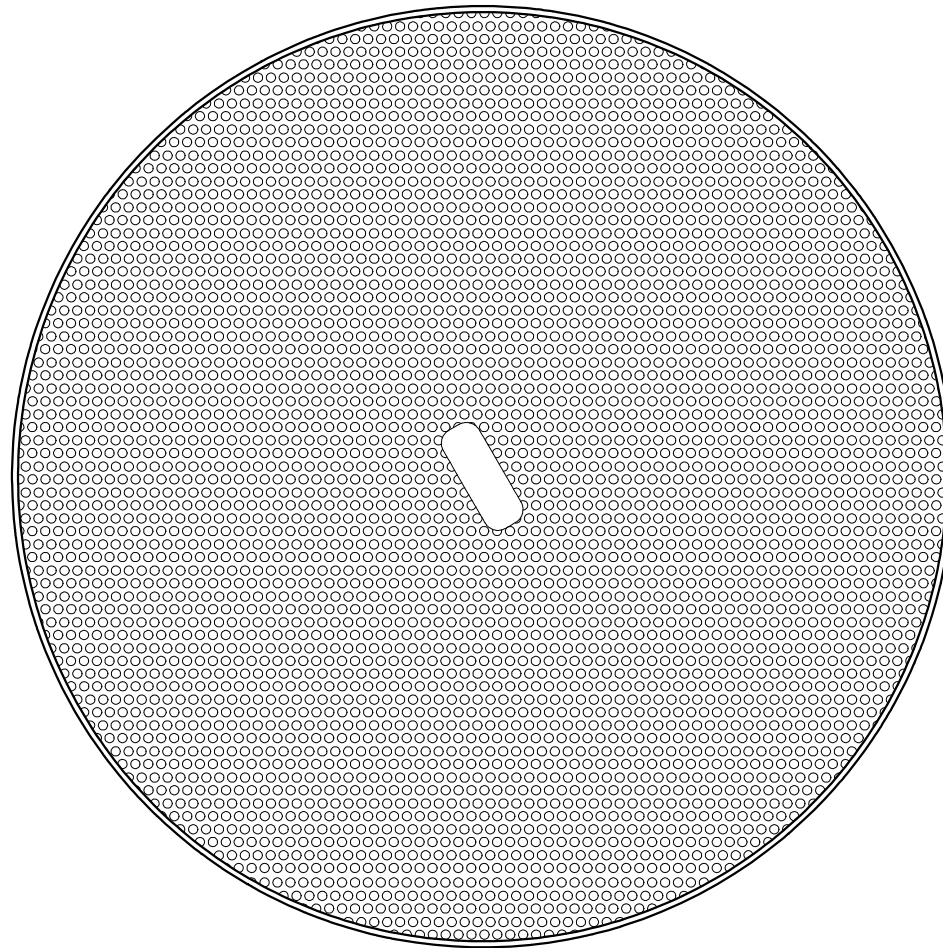
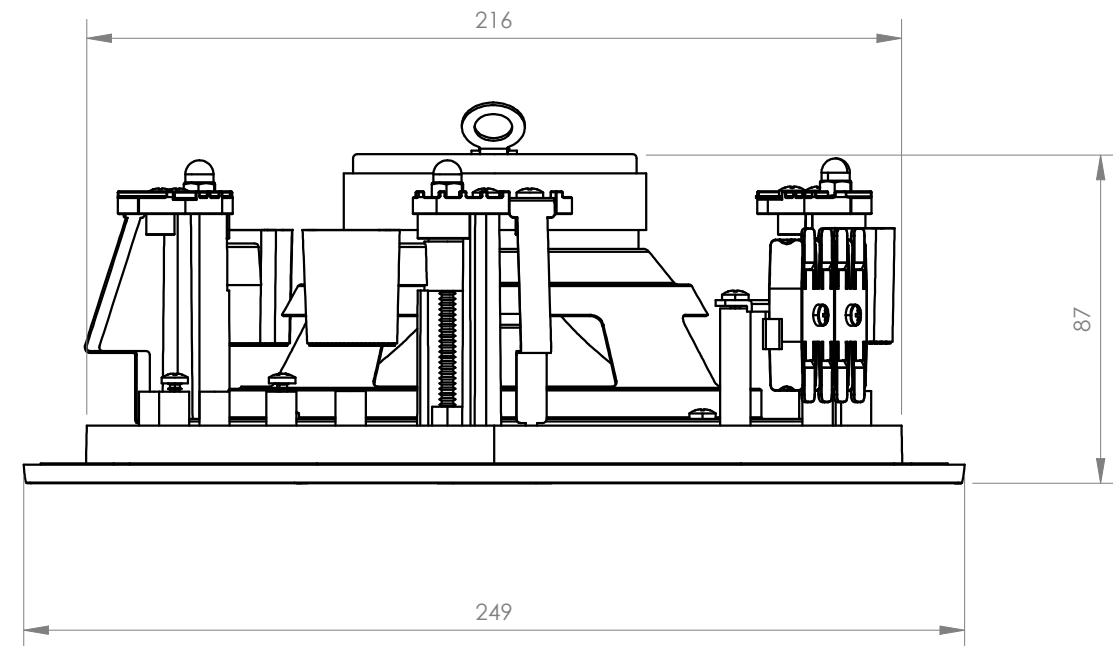

FONESTAR	Model	Description	Units	Scale
	SKY-6	LOW IMPEDANCE CEILING LOUDSPEAKER	mm	1:2